

Broadband Optical Switch Module

1x1, Dual 1x1, 1x2, 2x2, USB/GUI, TTL, Manual Push Button

(350 to 2400nm, SM, PM, MM, Bidirectional)



DATASHEET

[Return to the Webpage](#)

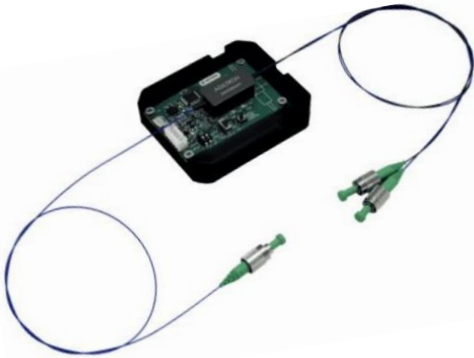

Features

- Convenient control: USB, TTL, Manual Button
- Ultrabroadband: 350 to 2400nm
- All fiber types, SM, PM, MM
- Low insertion loss
- Continuous transmission without gap

Applications

- Laser Systems
- Reconfigurable Optics
- Instrumentations

Legal notices: All product information is believed to be accurate and is subject to change without notice. Information contained herein shall legally bind Agiltron only if it is specifically incorporated into the terms and conditions of a sales agreement. Some specific combinations of options may not be available. The user assumes all risks and liability whatsoever in connection with the use of a product or its application.

Rev 02/21/25

The FFSM Series fiber optic switch module feature easy to use and exceptional optical performance of ultra-broad wavelength transmission that is limited only by the fiber, nearly lossless, available in all fiber types, including single-mode, multimode, polarization maintaining, double cladding, and special fibers, and bidirectional. The module integrates several activation methods including manual Push Button, TTL, and USB with a user-friendly GUI Windows™ program. The unit has a mini USB connector and a 5-PIN connector. It can be powered by the mini USB connector to a computer or an accompanying cellphone 5V wall plug power supply. Latching operation preserves the selected optical path after the electrical power has been removed. Command code is also provided for customer modification. The superior optical performance is achieved via a patented MEMS technology in which light propagates in a continuous medium without interruptions offering unprecedented low optical loss, little wavelength dependence with no coatings. For single-mode fiber selection, please notice fiber has a cutoff wavelength below which the fiber no longer maintains SM.

Lightpath in the device is bidirectional. Wall pluggable 100-240 VAC power supply and cable are included.

The order table includes a list of standard control interfaces. Additionally, we provide a list of commands to assist customer engineers in coding. For those who require it, we offer a code-writing service for customer interfaces at an additional charge.

This switch uses a specially formulated index-matching liquid that does not generate fluorescent. The liquid fills a gap of less than 5 μm.

Switches with PM fibers transmit both polarizations the same way as the fiber.

Specifications

Parameter	Min	Typical	Max	Unit
Wavelength	350		2500	nm
Insertion Loss ^[1]	0.01	0.2	0.4	dB
Wavelength Dependent Loss			0.01	dB
Polarization Dependent Loss			0.05	dB
Polarization Extinction Ratio ^[2]	18			dB
Return Loss	50 (SM)			dB
	35 (MM) ^[3]			dB
Cross Talk On/Off Ratio	50		75	dB
Optical Rise/Fall Time (PM)	5		20	ms
Optical Rise/Fall Time (SM, MM)	1	2	5	ms
Repetition Rate (PM)			5	Hz
Repetition Rate (SM,MM)			5	Hz
Repeatability			± 0.02	dB
Durability	10 ⁸			cycles
Operating Optical Power ^[6]		0.5	0.7	W
Operating Voltage	4.3		4.5	VDC
Operating Current		30	60	mA
Switching Type		Latching		
Operating Temperature	-40		80	°C
Storage Temperature	-50		90	°C

Notes:

[1]. For 1x2, 1x2, Dual 1x1, Dual 1x2, SMF-28 fiber, Typical loss is 0.3dB.

Ultra-low loss version is special order. Excluding Connectors.

For Small core fibers, the specs are reduced.

For Full 2x2, 2x2 bypass, SMF-28 fiber, Typical loss is 1dB.

Ultra-low loss version is special order. Excluding Connectors.

For Small core fibers, the specs are reduced

[2]. For PM fiber only

[3]. For MM fiber with laser CPR<14

[4]. For PM type mainly

[5]. For SM, MM type, 15ms including the electrical delay as shown in the testing data

[6]. For SM 28 and MM fibers, other wavelength SM fiber see the chart at the end.

Broadband Optical Switch Module

1x1, Dual 1x1, 1x2, 2x2, USB/GUI, TTL, Manual Push Button

(350 to 2400nm, SM, PM, MM, Bidirectional)



DATASHEET

Mechanical Dimensions (Unit: mm)

fast speed version package

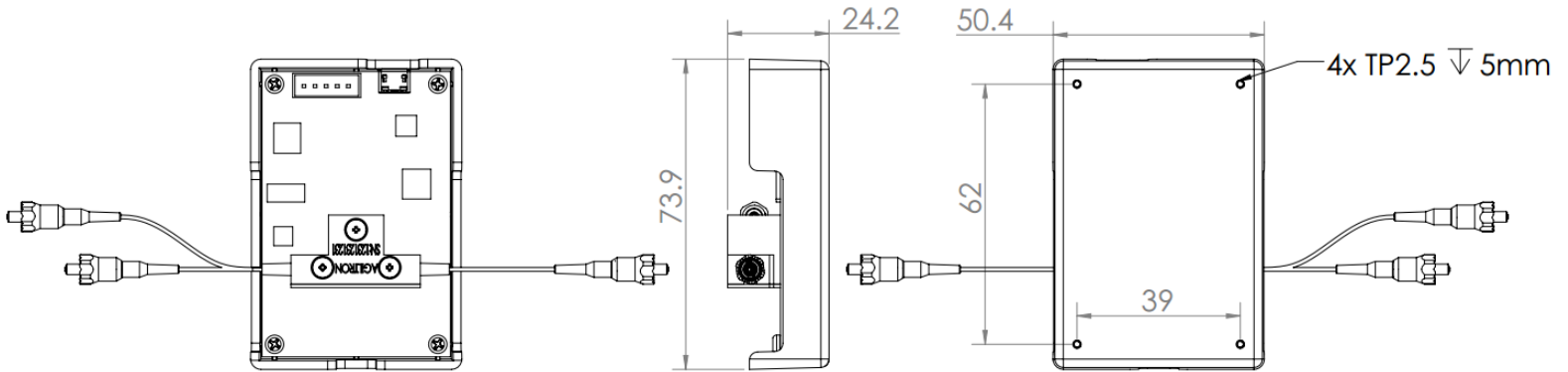

slow speed version package

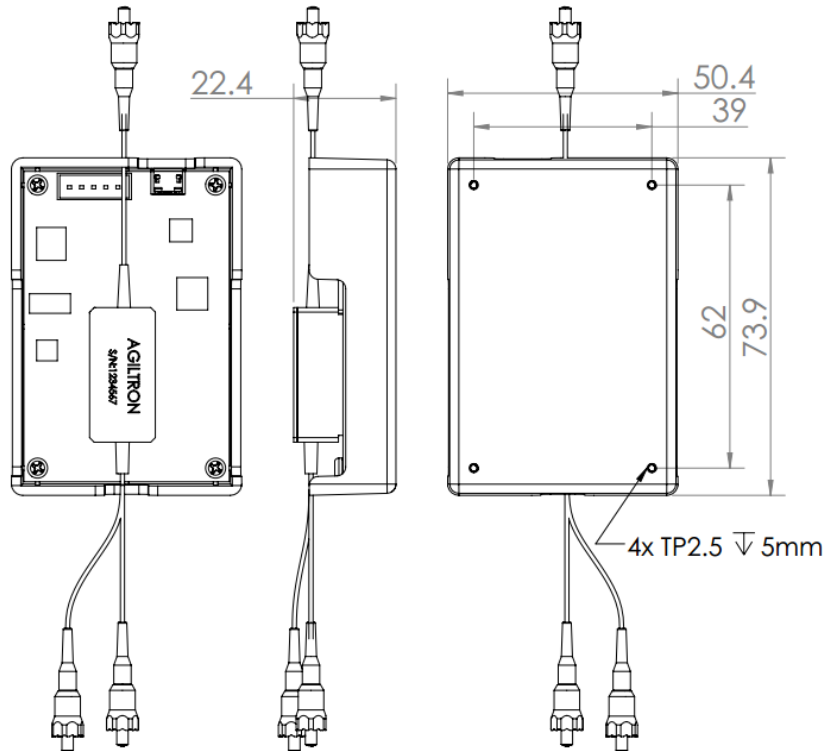

*Product dimensions may change without notice. This is sometimes required for non-standard specifications.

Broadband Optical Switch Module

1x1, Dual 1x1, 1x2, 2x2, USB/GUI, TTL, Manual Push Button

(350 to 2400nm, SM, PM, MM, Bidirectional)



DATASHEET

Optical Path Diagram

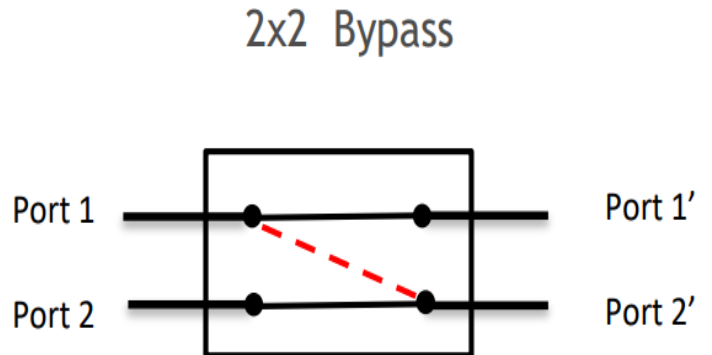
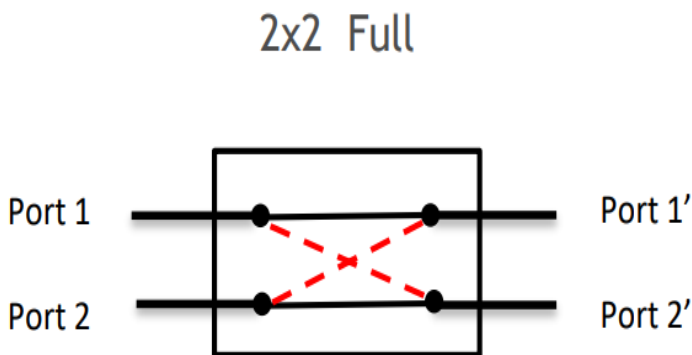
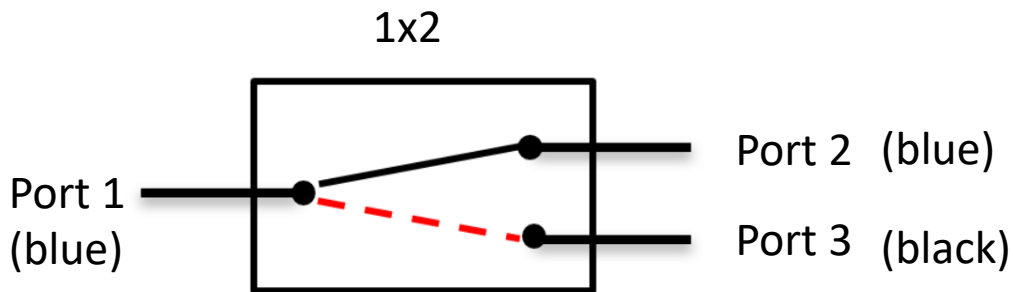
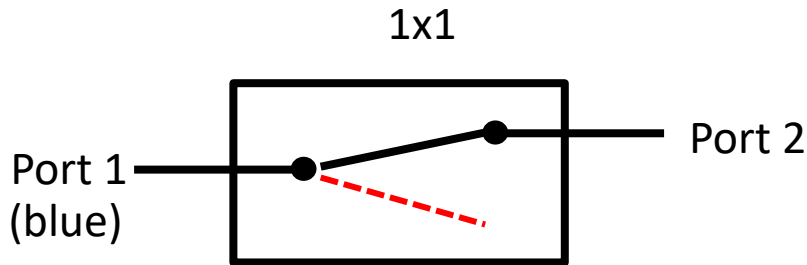

Broadband Optical Switch Module

1x1, Dual 1x1, 1x2, 2x2, USB/GUI, TTL, Manual Push Button

(350 to 2400nm, SM, PM, MM, Bidirectional)



DATASHEET

Response Speed (SM/MM)

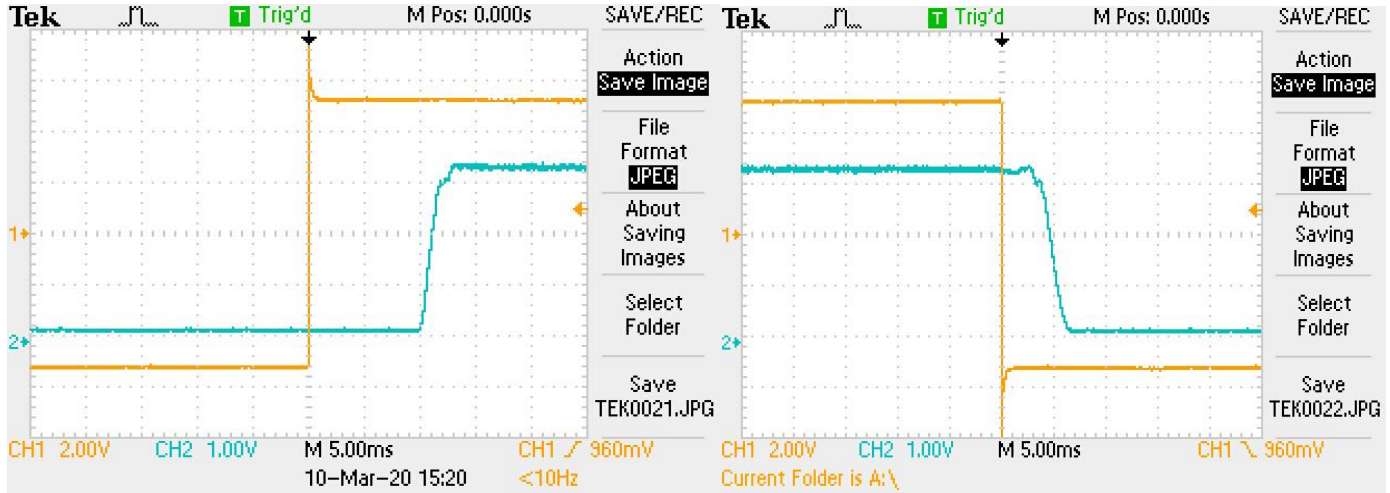

Rise

Fall

Optical Power Handling vs Wavelength For Single-Mode Fibers

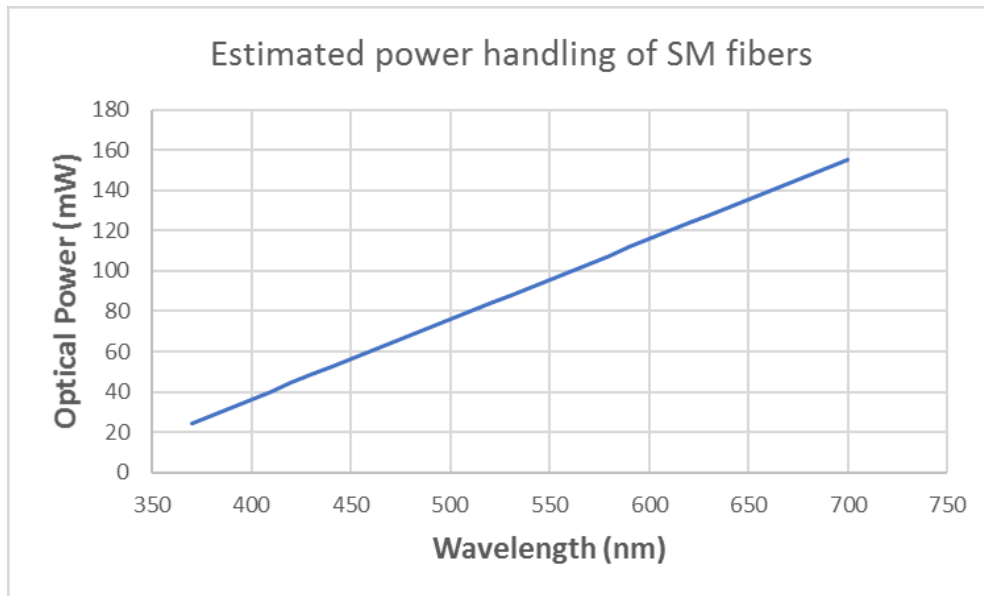

Broadband Optical Switch Module

1x1, Dual 1x1, 1x2, 2x2, USB/GUI, TTL, Manual Push Button

(350 to 2400nm, SM, PM, MM, Bidirectional)



DATASHEET

Ordering Information

Prefix	Type	Switch	Test Wavelength ^[2]	Fiber Type	Fiber Cover	Fiber Length	Connector
FFSM-	1x1 (Transparent) ^[1] = 11 1x1 (Opaque) = 1D 1x2 = 12 2x2 = 22 Special = 00	Latching = L Non-Latching = N	488 = 4 360 = A 430 = B 532 = 5 630 = 6 780 = 7 850 = 8 980 = 9 1060 = 1 1310 = 3 1550 = C 2000 = 2 Special = 0	<i>Pick from below table</i>	Bare fiber = 1 900um tube = 3 Special = 0	0.25m = 1 0.5m = 2 1.0m = 3 Special = 0	None = 1 FC/PC = 2 FC/APC = 3 SC/PC = 4 SC/APC = 5 ST/PC = 6 LC/PC = 7 Duplex LC/PC = 8 MTP = 9 LC/APC = A LC/UPC = U Special=0

[1]. Transparent means light passes without activation. Opaque means light is blocked at the nonactivation state.

[2]. The device is ultra-broadband limited by fiber transmission. However, we only test at one selected wavelength to save cost. If a customer needs to test at several wavelengths, the selection is special =0 with added cost.

Note:

- ☐ **PM1550** fiber works well for **1310nm**

Fiber Type Selection Table:

01	SMF-28	34	PM1550	71	MM 50/125µm
02	SMF-28e	35	PM1950	72	MM 62.5µm
03	Corning XB	36	PM1310	73	105/125µm
04	SM450	37	PM400	74	FG105LCA
05	SM1950	38	PM480	75	FG50LGA
06	SM600	39	PM630	76	STP 50/125
07	780HP	40	PM850	77	
08	SM800	41	PM980	78	
09	SM980	42	PM780	79	
10	Hi1060	43	PM350	80	
11	SM400	44	PM405	81	UV180nm
12		45	PM460		
13		46			

Fiber Core Alignment

Note that the minimum attenuation for these devices depends on excellent core-to-core alignment when the connectors are mated. This is crucial for shorter wavelengths with smaller fiber core diameters that can increase the loss of many decibels above the specification if they are not perfectly aligned. Different vendors' connectors may not mate well with each other, especially for angled APC.

Fiber Cleanliness

Fibers with smaller core diameters (<5 µm) must be kept extremely clean, contamination at fiber-fiber interfaces, combined with the high optical power density, can lead to significant optical damage. This type of damage usually requires re-polishing or replacement of the connector.

Maximum Optical Input Power

Due to their small fiber core diameters for short wavelength and high photon energies, the damage thresholds for device is substantially reduced than the common 1550nm fiber. To avoid damage to the exposed fiber end faces and internal components, the optical input power should never exceed 20 mW for wavelengths shorter 650nm. We produce a special version to increase the how handling by expanding the core side at the fiber ends.

Broadband Optical Switch Module

1x1, Dual 1x1, 1x2, 2x2, USB/GUI, TTL, Manual Push Button

(350 to 2400nm, SM, PM, MM, Bidirectional)



DATASHEET

Typical Fiber Transmissions

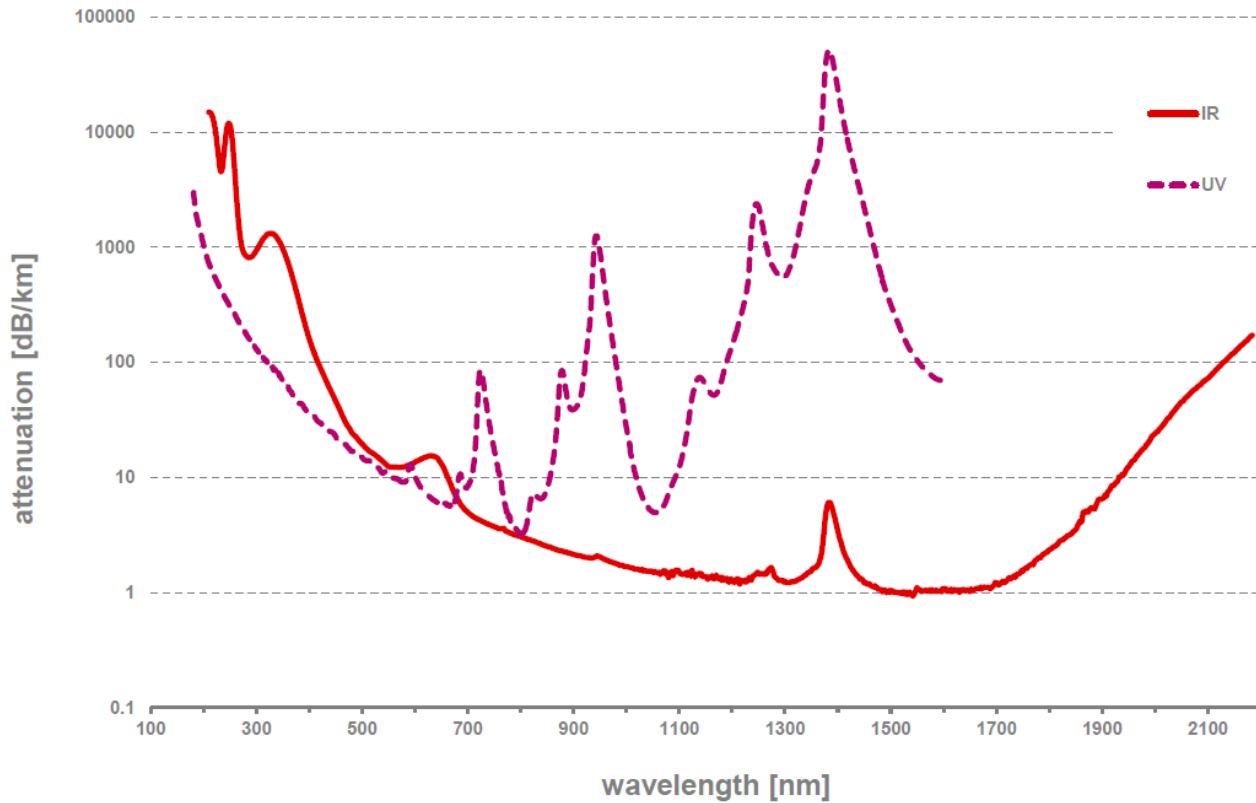

Broadband Optical Switch Module

1x1, Dual 1x1, 1x2, 2x2, USB/GUI, TTL, Manual Push Button

(350 to 2400nm, SM, PM, MM, Bidirectional)



DATASHEET

Electrical Connector Configurations

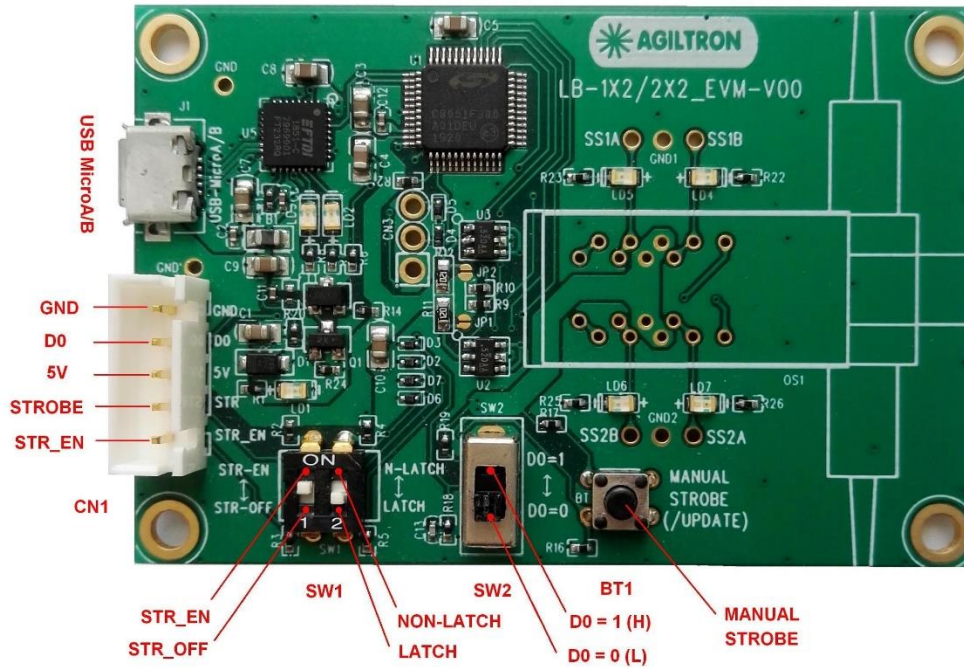

Power Voltage Input DC	Mini 4.9V	Max 5.2V
------------------------	-----------	----------

The two configuration switches S1 and S2 are preset to match the switch type. Do not change it.

Manual Operation Instruction

- **Power the Board**

The unit can be powered up via the Micro USB port connecting to a computer or a cellphone wall plug power supply.

- **Manual Push Button Control**

When using Manual Push Button Control, SW1-1 should be set to **STR_EN**.

Once the board is powered (LED on), the unit can be easily controlled by pushing the **STROBE** button, the light path will be changed accordingly.

TTL Operation Instruction

- **Power the Board**

The unit can be powered up via the Micro USB port connecting to a computer or a cellphone wall plug power supply.

- **TTL Control**

When using TTL Control, SW1-1 should be set to **STR_OFF**.

The unit can be controlled by a standard TTL Signal. Sending a **HIGH** voltage (>3.5V < 5V) to the **D0** pin in the 5 pin connector, and the light path will change. Sending a **LOW** voltage (0-0.8V) to the **D0** pin in the 5 pin connector light path will change again.

Broadband Optical Switch Module

1x1, Dual 1x1, 1x2, 2x2, USB/GUI, TTL, Manual Push Button

(350 to 2400nm, SM, PM, MM, Bidirectional)



DATASHEET

Computer Graphic Software User Guide

- **Install the Program**

Click on setup.exe for the automatic installation, which should be provided with the product.

- **Power and Connect the Board**

Use the Micro-USB to USB cable to connect the board with the PC with software installed. Remember to set SW1-1 to STR_EN.

- **Run the Program**

Run the "Switch Operation Program.exe" and the program will open the configuration window. Select the correct Switch Group and select the specific Switch Type. Then click the "Connect" button and the program will establish the connection between PC and board.

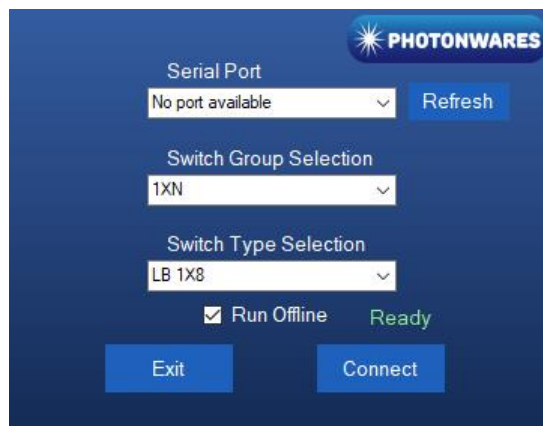

- **Create and edit testing time sequence**

Add step: Click the "Add Step" button in the menu strip or click the "+(ADD)" button would both add a step to the Programmable Running Sheet.

Delete step: Click the "Delete Step" button in the menu strip or click the "-(DEL)" button would both delete a step in the Programmable Running Sheet.

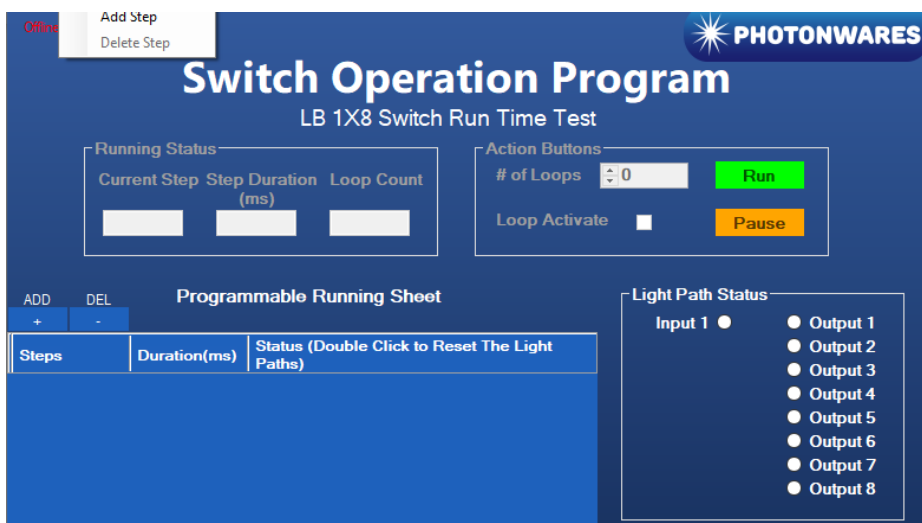

Broadband Optical Switch Module

1x1, Dual 1x1, 1x2, 2x2, USB/GUI, TTL, Manual Push Button

(350 to 2400nm, SM, PM, MM, Bidirectional)



DATASHEET

Edit step: There are two things that you can modify for one step. One is the light path, and the other is the duration for each step. Double click the cell that you want to modify, and the program will allow you to modify the setting.

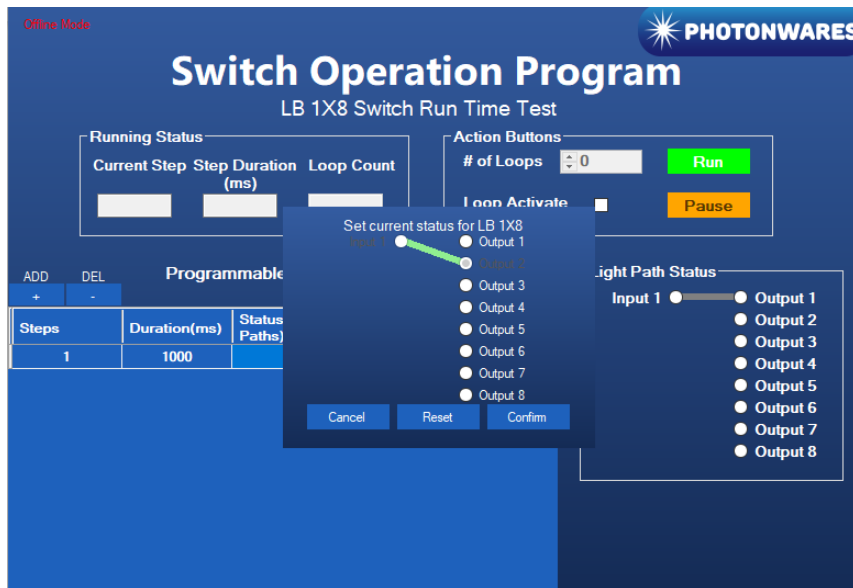
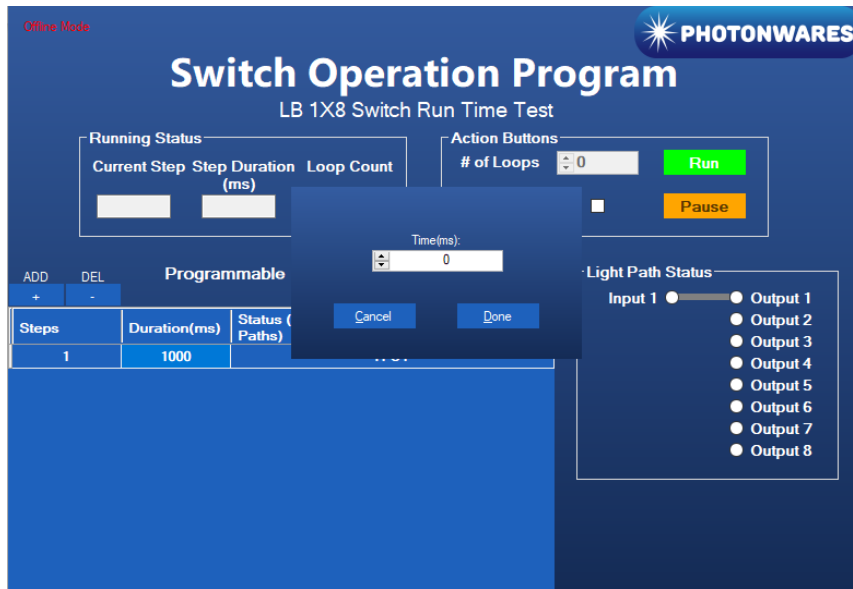

Broadband Optical Switch Module

1x1, Dual 1x1, 1x2, 2x2, USB/GUI, TTL, Manual Push Button

(350 to 2400nm, SM, PM, MM, Bidirectional)



DATASHEET

Computer Interface Options

The USB interface working as a Virtual COM port which is compatible with LabView, Matlab. We provide **LabView** and **Matlab** interface software at extra cost.

A Windows GUI and UART command list will be provided for test and software development.

Command List

Command in Serial

The serial communication should be set in **9600 baud rate, none parity, 8 data bits, 1 stop bits.**

```
0x01 0x12 0x00 0x01 ---- Switch to status 1
```

```
0x01 0x12 0x00 0x02 ---- Switch to status 2
```

In **Matlab**,

Example code as below:

```
s=serialport("COM1", 9600, "Timeout", 5);
```

```
Write(s, [1, 18, 0, 1], "uint8");
```

```
for status 1
```

```
Write(s, [1, 18, 0, 2], "uint8");
```

```
for status 2
```